

TOC

Car Signal Components

- Round and Square Pushbutton Assembly 394
- Stop Switches, "Soft Touch" Button 395
- Lantern and Hall Station Plates – Arrows and Diffusers 395
- Hall Station Plates 396
- Position Indicator Assembly..... 396
- Digital Position Indicator Components..... 396
- Gongs 396
- Lantern and Hall Station Plates Arrows and Diffusers 396
- Key Switches..... 397
- Capacitors 397
- Bezels 397

PC Boards and Timers..... 398

Lamps 398

Fuses 398

Relays 399

PC Boards and Timers

- Tube Base Relays..... 399

Relays

- IBM Relays..... 400

Transformers 401

Resistors

- Adjustable Resistor 10-1/2"..... 401

Contact Kits 402

Pump Belts

- Hydraulic Split Seal Stack Packing..... 402

Valve Kits 402

Seals 402

Hatch Equipment

- Limit Switch..... 403

Wheels 404

US

Car Signal Components



1

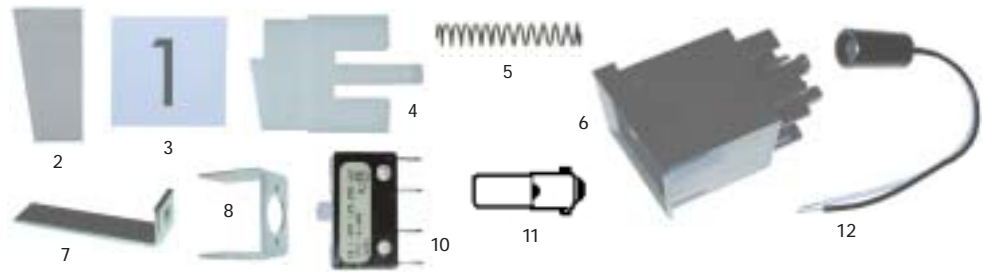

Square Pushbutton Assembly

Item	S.E.E.S. #	U.S. #	Description
1	US-B32A	167-03017-100 167-03010-100	Pushbutton assembly complete , square black housing, white button insert, specify marking: i.e. US-B32A-Door Open
2	US-B14	467-01006-007	Clear Cap , square plastic button cap
3	US-B23-	467-01012-007	Insert , square white button insert, specify marking i.e. US-B23-Door Open
4	US-B19	467-01005-007	Body , square white molded plastic button body
5	US-B25	920-36001-000	Spring 1/2" x .088" O.D. x .010" (4 required per assembly)
6	US-B20	467-01001-007	Housing , square black molded plastic button housing
7	US-B22A	167-02014-700	Clamp , pushbutton " L " clamp
8	US-B22B		Clamp , pushbutton " U " clamp
9	US-B26	467-00026-007	Micro switch licon subminiature
10	ML-8	930-27004-000	Lamp , 60 MB, 60 V
11	US-B24	940-31001-000	Lamp socket mini bayonet .575" O.D.
	US-B19C	167-03014-002	Spacer for square button, to California code



1
(1-1/4" dia.)

Round Pushbutton Assembly

Item	S.E.E.S. #	U.S. #	Description
1	US-B40	167-03011-100	Pushbutton assembly complete , round black housing, white button insert, specify marking, i.e. US-B40-Alarm
2	US-B38	467-05006-007	Clear cap , round plastic button cap
3	US-B23A-	467-01012-007	Insert , round white button insert, specify marking i.e. US-B23A-Alarm
4	US-B39	467-05005-007	Body , round white molded plastic button body
	US-B39C	167-03014-001	Spacer for round button, California code
5	US-B25	920-36001-000	Spring 1/2" x .088" O.D. x .010" (4 required per assembly)
	US-B25A		Spring , heavy duty, 1/2" fire service switch, California code
6	US-B37	467-05001-007	Housing , round black molded plastic button housing
7	US-B22A	167-02014-700	Clamp , pushbutton " L " clamp
8	US-B22B		Clamp , pushbutton " U " clamp
9	US-B26	467-00026-007	Microswitch licon subminiature
10	ML-8	930-27004-000	Lamp , 60 MB, 60V
11	US-B24	940-31001-000	Lamp socket mini bayonet .575" O.D.

Car Signal Components

Stop Switches

S.E.E.S. #	U.S. #	Description
US-B15A	167-03012-100	Stop Switch Assembly , Square black molded plastic housing with red insert marked "PULL-EMERGENCY-STOP"
US-B15B	167-03013-100	Stop Switch Assembly , Round black molded plastic housing with red insert marked "PULL-EMERGENCY-STOP"
US-B15C	467-05010-007	Button , round, and actuator for stop switch assembly US-B15B
US-B15D	467-05008-007	Mount , for stop switch assembly US-B15B
US-B16	467-01003-007	Housing , Square, black stop switch housing for US-B15A
US-B17	167-02013-700	Arm Actuator assembly, Includes: Body, Insert and Clear Cap
US-B18	467-00002-007	Toggle Switch , for US-B15A and US-B15B
US-B23-STOP	467-01012-007	Insert for Square Emergency Stop Switch, red insert marked "Pull Emergency Stop"
US-B23A-STOP	467-05012-007	Insert for Round Emergency Stop Switch, red insert marked "Pull Emergency Stop"

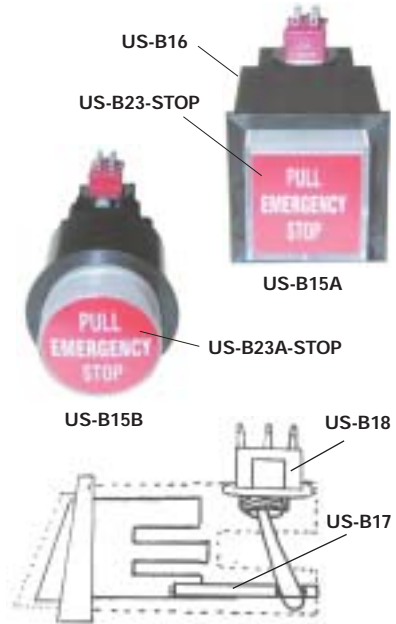

"Soft Touch" Button

S.E.E.S. #	U.S. #	Description
US-B50-BLANK	166-01020-702, 166-10034-100	Button assembly, Soft Touch Style, 24VDC if used in series, 48VDC if used alone, blank
US-PC14	146-05054-300	P.C. Board , for car, used on Soft Touch series
US-PC15	146-05055-300	P.C. Board , for hall, used on Soft Touch series

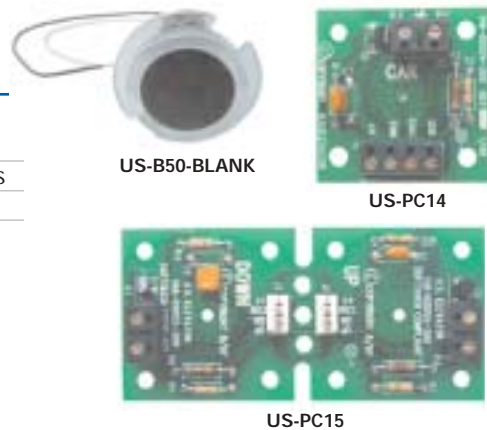

Lantern and Hall Station Plates – Arrows and Diffusers

S.E.E.S. #	U.S. #	Description
US-B3	167-30004-107	Lantern plate , S/S 4-3/4" x 10-3/4", horiz., for single arrow, terminal floors
US-B3A	167-30001-107	Lantern plate , S/S 4-3/4" x 10-3/4", vertical, for single arrow, terminal floors
US-B4	167-30006-107	Lantern plate , S/S 4-3/4" x 10-3/4", horizon. for double arrows, intermediate floors
US-B4A	167-30003-107	Lantern plate , S/S 4-3/4" x 10-3/4", vertical for double arrows, intermediate floors
US-B5	167-30002-107	Lantern plate , S/S 3-3/4" x 10-3/4", vertical for double arrows, intermediate floors
US-B27	467-00012-007	Arrow , extruded large plastic, 2-1/2" sides, 1-5/8" base, 3 mounting pins on back
US-B27A	467-00028-007	Lens , white flat lantern arrow on plastic mounting base
US-B28	167-03004-700	Diffuser , green, for lantern arrow for US-B27A
US-B29	167-03003-700	Diffuser , red, for lantern arrow for US-B27A

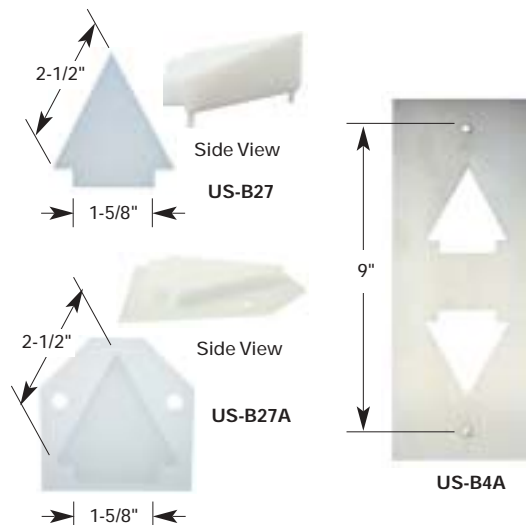

Car Signal Components

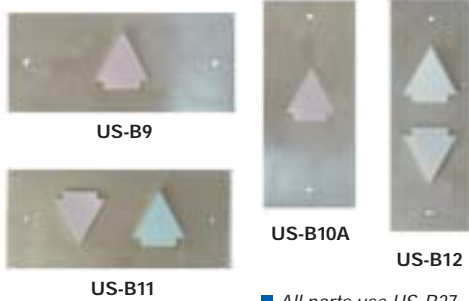

■ All parts use US-B27.

Lantern and Hall Station Plates Arrows and Diffusers

S.E.E.S. # Description

US-B9	Lantern plate, S/S, 4-3/4" x 10-3/4", Horiz., Terminal Green
US-B9A	Lantern plate, S/S, 4-3/4" x 10-3/4", Horiz., Terminal Red
US-B10	Lantern plate, S/S, 4-3/4" x 10-3/4", Vert., Terminal Green
US-B10A	Lantern plate, S/S, 4-3/4" x 10-3/4", Vert., Terminal Red
US-B11	Lantern plate, S/S, 4-3/4" x 10-3/4", Horiz., Inter. Complete
US-B12	Lantern plate, S/S, 4-3/4" x 10-3/4", Vert., Inter. Complete
US-B13	Lantern plate, S/S, 3-3/4" x 10-3/4", Vert., Inter. Complete

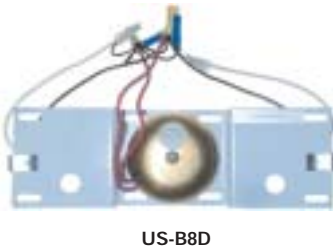

Gongs

S.E.E.S. # U.S. # Description

US-B8A	167-31002-001	Gong assembly, Horizontal, Single lamp, Relay Controller
US-B8C	167-31002-002	Gong assembly, Horizontal, Single lamp, Microprocessor
US-B8B	167-31003-001	Gong assembly, Horizontal, Double lamp, Relay Controller
US-B8D	167-31003-002	Gong assembly, Horizontal, Double lamp, Microprocessor
US-B8E	167-31000-001	Gong assembly, Vertical, Single lamp, Relay Controller
US-B8G	167-31000-002	Gong assembly, Vertical, Single lamp, Microprocessor
US-B8F	167-31001-001	Gong assembly, Vertical, Double lamp, Relay Controller
US-B8H	167-31001-002	Gong assembly, Vertical, Double lamp, Microprocessor
US-B24A	940-31002-000	Lamp Socket .5" O.D. with clips, for gongs



Hall Station Plates

S.E.E.S. # U.S. # Description

US-B1	167-61001-107	Hall plate, S/S, 3" x 7", single square hole, for terminal floors
US-B1A	167-65001-107	Hall plate, S/S, 3" x 7", single round hole, for terminal floors
US-B2	167-61003-107	Hall plate, S/S, 3" x 7", double square holes, for intermediate floors
US-B2A	167-65003-107	Hall plate, S/S, 3" x 7", double round holes, for terminal floors

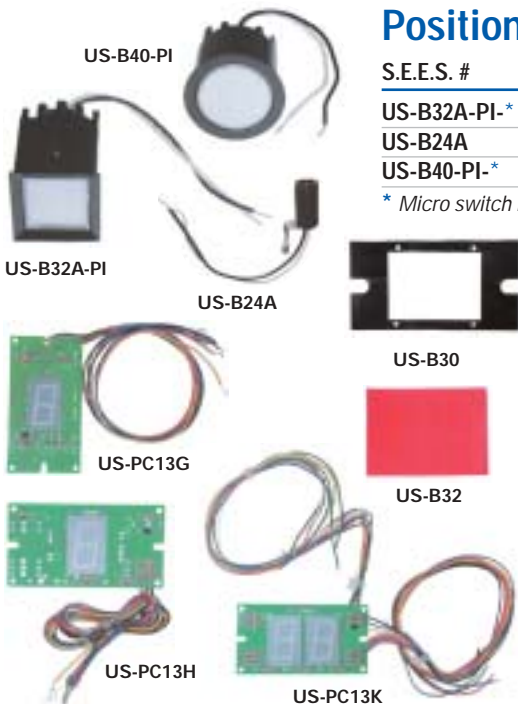

Position Indicator Assembly

S.E.E.S. # U.S. # Description

US-B32A-PI*	167-03017-100	Square P.I. assembly with black housing, specify marking
US-B24A	940-31002-000	Socket .575" O.D. with clip
US-B40-PI*	167-03011-100	Round P.I. Assembly, black housing, specify marking

* Micro switch not used on these assemblies

Digital Position Indicator Components

S.E.E.S. # U.S. # Description

US-PC13G	154-05006-301	P.C. board for vertical Digital P.I. single character
US-PC13H	145-05097-301	P.C. board for horizontal Digital P.I., single character
US-PC13J	145-05098-302	P.C. board for vertical Digital P.I. double character
US-PC13K	145-05097-302	P.C. board for horizontal Digital P.I. double character
US-B30	467-00022-007	Black Bezel retainer for digital position indicator
US-B31	467-00020-007	Black Bezel for digital P.I.
US-B31A	467-00021-007	Clear Bezel for digital P.I.
US-B32	167-03005-700	Red Lens for digital P.I.

Car Signal Components

Key Switches

S.E.E.S. #	U.S. #	Description
US-KS1-HALL		Fire service Phase I , round keyswitch, bypass/off/on, for hall use, Bypass at 10, Off at 12, On at 2
US-KS1-CAR		Fire service Phase II , round keyswitch, off/hold/on for car use, Off at 10, Hold at 12, On at 2
US-KS2-HALL		Fire service Phase I , square keyswitch, bypass/off/on, for hall use Off at 10, Hold at 12, On at 2
US-KS2-CAR		Fire service Phase II , square keyswitch, off/hold/on, for car use, Bypass at 10, Off at 12, On at 2
US-KS2A		Key, USE#1 for Fire Service Phase 1 & 2
US-KS2B		Key, USE#2 for Hall and Car Access & Inspection
US-KS3	167-03046-001	Run/Stop , Black, two position round switch to replace stop switch
US-KS3B		Direction Run Switch , 3 Position UP-OFF-DOWN. Spring return to center (OFF) position. Keyed to USE#3 key.
US-KS3-R		Run/Stop , Red, two position round switch to replace stop switch
US-KS3A		Key, USE#3 for Light, 1 & 2 Speed Fan, Fan and Light, Door Hold, Run Stop, Hall Park
US-KS4		Run/Stop , Black, two position square switch to replace stop switch
US-KS4A		Key, USE#4 for Ind. Svc., Hospital Emergency, Lockout, Car Park
US-KS4-R		Run/Stop , Red, two position square switch to replace stop switch
US-KS5A		Key, USE#5 for Car and Hall Floor Lockout



Bezels

S.E.E.S. #	U.S. #	Description
US-KS1-A	467-01014-001	Bezel , round black blank, 1-3/4" O.D., raised inner ring 1-9/16" O.D., 3/4" I.D., 2 straight sides
US-KS1-A-STOP-RUN		Bezel , round black as above, marked "STOP/RUN"
US-KS1-B	467-01014-102	Bezel , round red blank, 1-3/4" O.D., raised inner ring 1-9/16" O.D., 3/4" I.D., 2 straight sides
US-KS1-B-CAR		Bezel , round red as above, marked "OFF/HOLD/ON"
US-KS1-B-HALL		Bezel , round red as above, marked "BYP/OFF/ON"
US-KS1-C	467-01015-001	Bezel , square black, blank, 1-5/8" H x 1-7/16" W, raised inner ring 10/16" O.D. w/ 3/4" I.D. w/ 2 straight slanted inner sides
US-KS1-D	467-01015-102	Bezel , square red, blank, 1-5/8" H x 1-7/16" W, raised inner ring 10/16" O.D. w/ 3/4" I.D. w/ 2 straight inner sides
US-KS1-D-CAR		Bezel , square red marked "OFF/HOLD/ON"
US-KS1-D-HALL		Bezel , square red as above, marked "BYP/OFF/ON"
US-KS1-E	467-05022-001	Backing plate , round black 2" O.D. 3/4" I.D., 2 flat outer sides (1-3/4" O.D.)
US-KS1-F		Bezel , square black, as above marked, 1-5/8" H x 1-7/16" W, raised inner ring 10/16" O.D. w/ 3/4" I.D. w/ 2 straight slanted inner sides marked "RUN/STOP" Bezels

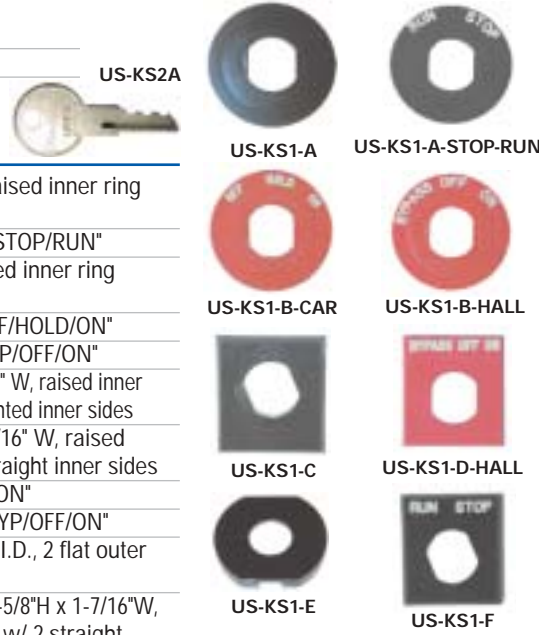

Capacitors

S.E.E.S. #	U.S. #	Description
US-CAP1	936-50004-000	Capacitor 0.25Mfd, 600V
US-CAP2	936-10032-000	Capacitor 300Mfd, 150V
US-CAP3	936-60022-000	Capacitor 108-130Mfd, 330VAC
US-CAP3A	936-60022-001	Capacitor 215-260Mfd, 330VAC
US-CAP4	936-40003-000	Capacitor 320Mfd, 450VDC
US-CAP5	936-10027-000	Capacitor 150Mfd, 150VDC
US-CAP6	936-60042-000	Capacitor 5300Mfd, 100VDC



US

Fuses



F-5SB thru F-32SB



F-17A thru F-26



F-30 thru F-41

Lamps

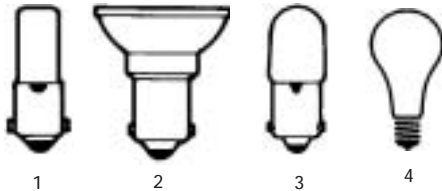

1

2

3

4



US-B24



US-B24A

PC Boards and Timers



US-PC5



US-PC5A



US-PC6



US-PC7



US-PC1

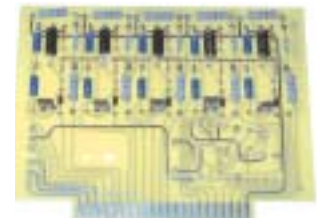

US-PC2



US-PC3



US-PC4

S.E.E.S. #	U.S. #	Description
F-5SB	930-15016-000	Fuse, 0.1 amp, 250V, slo-blo
F-12SB	930-15001-000	Fuse, 0.30 amp, 250V, slo-blo
F-11SB	930-15020-000	Fuse, 1.25 amp, 250V, slo-blo
F-32SB	940-18009-000	Fuse, 5 amp, 125V, slo-blo
F-17A	930-15004-000	Fuse, 0.75 amp, 250V
F-19	930-15006-000	Fuse, 2 amp, 250V
F-20	930-15007-000	Fuse, 3 amp, 250V
F-23	930-15009-000	Fuse, 6 amp, 250V
F-26	930-15010-000	Fuse, 10 amp, 250V
F-30	940-18001-000	Fuse, 1 amp, 250V, one-time
F-33	940-18002-000	Fuse, 3 amp, 250V, one-time
F-36	940-18003-000	Fuse, 6 amp, 250V, one-time
F-38	940-18004-000	Fuse, 10 amp, 250V, one-time
F-40	940-18005-500	Fuse, 15 amp, 250V, one-time
F-41	940-18006-000	Fuse, 20 amp, 250V, one-time

Fig.	S.E.E.S. #	U.S. #	Description
1	ML-8	930-27004-000	Lamp, 60MB, 60V
2	ML-27	930-27007-000	Lamp, 60RB, 60V
3	ML-68	940-24001-000	Lamp, 313, 28V
4	ML-141	940-24004-000	Lamp, 100 A/CL, utility lamp 100W, 250V
	US-B24		Lamp socket for buttons
	US-B24A		Lamp socket for gongs

S.E.E.S. #	U.S. #	Description
US-PC1	153-05008-300	Car Top Amplifier with nudging
US-PC2	153-05008-301	Car Top Amplifier w/out nudging
US-PC3	145-05063-300	Reverse Phase Amplifier 144-00032-00
US-PC4	144-00020-001	Amplifier, Photo Cell Sensor
US-PC5	144-00019-001	Receiver, Photo cell sensor
US-PC5A	144-00018-001	Lamp holder assembly, photo eye, for 60 RB Lamp.
US-PC6	144-00016-001	Hydro Control Board #1
US-PC7	144-00017-001	Hydro Control Board #2

PC Boards and Timers

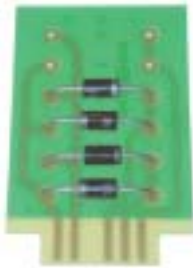

US-PC8



US-PC9



US-PC9B



US-PC-10

■ Octal base
plug-in timer

S.E.E.S. #	U.S. #	Description
US-PC8	144-00065-001	Rectifier Board
US-PC9	144-00066-001	Rectifier Board
US-PC9B	930-11059-000	Base for US-PC9 rectifier
US-PC10	144-00035-001	Timer, External Relay .5-5 Sec.
US-PC11	144-00039-001	Timer, External Relay .5-60 Sec.
US-PC12	144-00041-001	Timer, Internal Relay N/O .5-60 Sec
US-PC13	144-00067-001	Timer, Internal Relay N/C .5-60 Sec
US-PC13G	154-05006-301	Position Indicator PC Board Vertical, Single
US-PC13H	154-05005-301	Position Indicator PC Board Horizontal, Single
US-PC10A	145-05064-301	Timer, .5-5 Sec.
US-PC13A	145-05064-304	Timer, N/C .5-60 Sec.
US-PC13B	145-05064-303	Timer, N/O .5-60 Sec.
US-PC13F	145-05064-302	Timer, .5-60 Sec.
US-PC13E	145-05063-300	Reverse Phase Amplifier, printed circuit board
US-PC13D	144-00099-002	Adapter, Grey, for N/O, N/C and reversed phase timers
US-PC13C	144-00099-001	Adapter, White, for .5-5 and .5-60 second timers

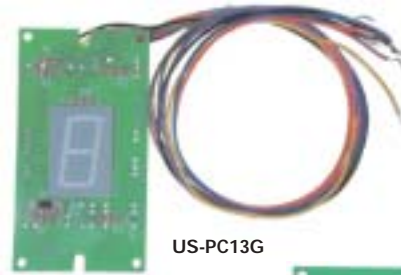

US-PC13G

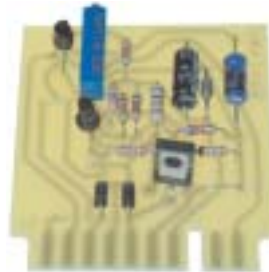

US-PC10A



US-PC13H



US-PC13E



US-PC13C



US-PC13D



US-R1

Relays

Tube Base Relays

S.E.E.S. #	U.S. #	Description
US-R1	930-35008-000, 930-35014-000	Delay Relay, Amperite, 50 N.O.60
US-R2	930-35009-000, 930-35012-000	Delay Relay, Amperite, 50 N.O.30
US-R3	930-35010-000	Delay Relay, Amperite, 50 N.O.5
US-R4	930-35011-000	Delay Relay, Amperite, 50 N.O.2
US-R5	930-35013-000	Delay Relay, Amperite, 50 N.O.180
US-R6	930-35015-000	Delay Relay, Amperite, 50 N.O.10
US-R7	930-35026-000	Delay Relay, Amperite, 50 N.O.8

Relays



PR-20



US-R12



US-R18



PR-38



US-R43



US-R43A



US-R42



ORP-45



US-R44



PR-28TC



PR-28BC



PR-35

IBM Relay Base



PR-31

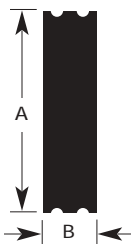

No. of Contacts	A	B
4 PDT	2"	5/8"
6 PDT	2"	15/16"
12 PDT	2"	1-7/8"

Relay Dimensions listed for identification assistance.



PR-35T

S.E.E.S. #	U.S. #	Description
PR-20	930-35029-000	Starter, reversing contactor 4PDT, 48VDC
US-R12	930-35030-000	Relay, type KUP, DPDT, 48 VDC
PR-38	930-35031-000, 930-35032-000	Relay, Flange mount, 3PDT Type KUP 48VDC
US-R14	930-35033-000, 930-35033-000	Relay, Flange mount Type KUP 3PDT 240VDC
US-R18	930-35053-000	Relay, Plug in Type K10-2P, 48VDC
US-R42	930-35051-000, 930-35037-000	Relay, Type R10-4PDT, 48VDC
US-R42A	930-37014-000	Base, Socket for 4PDT, R10-relay
US-R43	930-35052-000	Relay, R10-6PDT, 48VDC
US-R43A	930-37015-000	Base, Socket for R10-6PDT relay
US-R44	930-35038-000	Latch Relay, R10-4P, 48VDC
US-R44A	930-02001-000	Base, Socket for R10-4P Latch
ORP-45	930-35056-000	Relay, VC152A2B-120VAC
ORP-45A	930-35056-001	Relay, VC153A1B-120VAC
ORP-45B	930-35056-002	Relay, VC154A-120VAC

IBM Relays

S.E.E.S. #	U.S. #	Description
PR-28-BC		Clip, bottom hold down clip for relay
PR-28-TC		Clip, top hold down clip for relay
PR-30	930-35019-000, 769489	Relay, IBM 4PDT, 48VDC
PR-30S		Solid State Replacement for PR-30
PR-33	930-35017-000, 186685	Latching Relay, IBM 4PDT, 45VDC
PR-33S		Solid State Replacement for PR-33
PR-35	930-02000-000	Base, for 4PDT IBM relays
PR-31	930-02001-000, 769019	Relay, IBM 6PDT, 48VDC
PR-31S		Solid State Replacement for PR-31
PR-35C	930-35018-000	Base, for IBM 6PDT relay
PR-34	930-35020-000, 769488	Relay, IBM 12PDT, 48VDC
PR-34S		Solid State Replacement for PR-34
PR-35D	930-02002-000, 159943	Base, for IBM 12PDT relay
PR-35A	930-35004-000	Wire Contacts for all IBM Wire Relays
PR-35B		Taper pins for base wiring
PR-35T		Tool, IBM contact removal and insertion tool

Resistors



RES-53 thru RES-61

Adjustable Resistor 10-1/2"

S.E.E.S. #	U.S. #	Description		
RES-53	934-10055-000	Resistor	10 ohm	200 Watt
RES-54	934-10054-000	Resistor	25 ohm	200 Watt
RES-55	934-10063-000	Resistor	50 ohm	200 Watt
RES-56	934-10057-000	Resistor	100 ohm	200 Watt
RES-58	934-20206-000	Resistor	200 ohm	200 Watt
RES-59	934-10056-000	Resistor	250 ohm	200 Watt
RES-60	934-10062-000	Resistor	500 ohm	200 Watt
RES-61	934-10060-000	Resistor	1K ohm	200 Watt



RES-71

S.E.E.S. #	U.S. #	Description		
RES-71	934-10061-000	Resistor	500 ohm	20W, fixed

Transformers



US-TR1 thru US-TR11

S.E.E.S. #	U.S. #	Description	Primary Voltage	Secondary Voltage
US-TR1	940-38001-000	Transformer, 5 VA, for Alarm Bell	120	10
US-TR2	940-38011-000	Transformer, 1.2A	115	6.3
US-TR3	930-45012-000	Transformer, 2-4A	115/230	12/24
US-TR4	940-38012-000	Transformer, 0.25 KVA	200/220/240	55
US-TR5	940-38008-000	Transformer, 0.25 KVA	240/480	120/240
US-TR6	940-38009-000	Transformer, 0.5 KVA	240/480	120/240
US-TR7	940-38010-000	Transformer, 1 KVA	110/ 120/130	55
US-TR8	940-38007-000	Transformer, 1 KVA	240/480	120/240
US-TR9	940-38004-000	Transformer, 3 KVA	240/480	120/240
US-TR10	448-05001-850	Transformer, 5 A for MDU	200/240	45
US-TR11	448-05004-850	Transformer, 4 A for MDU	220/260	100/100

Seals



USPAC-26

Hydraulic Split Seal Stack Packing

S.E.E.S. #	U.S. #	Description
USPAC-26	437-00010-000	Packing Set, 4-1/2" x 5 1/2"
USPAC-27	437-00011-000	Packing Set, 5" x 6" x 1-1/2", Split
USPAC-27A	437-00023-000	Packing Set, 5-1/2" x 6-1/2", Split Autopak
USPAC-28	437-00012-000	Packing Set, 6" x 7" x 1/2", Soft Split Autopak
USPAC-29	437-00025-000	Packing Set, 7" x 8" x 1-1/2"
USPAC-30		Seal, worm shaft for #63 Machine

Valve Kits



MIS-208G

S.E.E.S. #	U.S. #	Description
MIS-208G	995-00044-001	Repair Kit for UC-1, UC-2, UC-2A
MIS-208G1	995-00044-002	Repair Kit for UC-3A, UC-4

Pump Belts



MIS-BLT8

S.E.E.S. #	U.S. #	Description
MIS-BLT8	990-10105-000	V-Belt 3V375/3VX375
MIS-BLT14	990-10103-000	V-Belt 3V530/3VX530
MIS-BLT15	990-10102-000	V-Belt 3V560/3VX560
MIS-BLT16	990-10101-000	V-Belt 3V600/3VX600
MIS-BLT17	990-10000-000	V-Belt 3V630/3VX630
MIS-BLT18	990-10106-000	V-Belt 3V670/3VX670
MIS-BLT19	990-10107-000	V-Belt 3V710/3VX710

Contact Kits



CKGE-5

S.E.E.S. #	Description
CKGE-5	Size 1, Contact Kit, 546-A301G-053, 546-A301G-002
CKGE-7	Size 2, Contact Kit, 546-A780G-002, 546-A780G-051
CKGE-9	Size 3, Contact Kit, 55-153677-G001, 55-153677-G002

Hatch Equipment

S.E.E.S. #	U.S. #	Description
MIS-181B	930-41014-000	Limit Switch , with roller, 1 N.O., 1 N.C.
MIS-184A	940-35011-000	Magnetic Switch N.O.

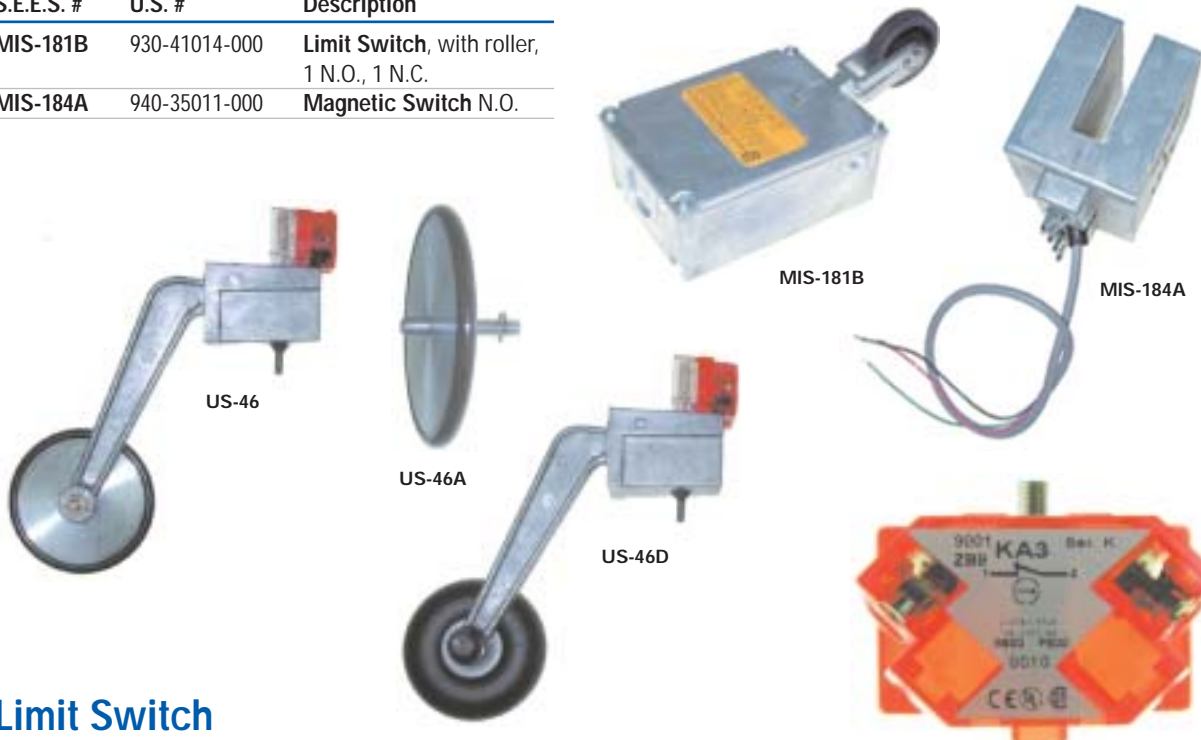

Limit Switch

S.E.E.S. #	U.S. #	Description
US-46	150-00116-001	Limit Switch assembly, N.C.
US-46A	940-00012-000, 150-00280-001, 150-00142-007	Roller with clip , for Limit Switch US-46
US-46B	940-02004-000	Contact Block assembly, N.C., for limit switch
US-46F	940-02004-001	Contact Block assembly, N.O., for limit switch
US-46C	990-11405-000	Retaining Ring for roller 3/16" shaft
US-46D	150-00643-001	Limit Switch , N.C., new style, with air tire
US-46E	960-00062-000	Roller for limit switch US-46D
US-46T		Tire replacement for US-46A

S.E.E.S. #	U.S. #	Description
MIS-119	990-00021-000	Door Key with collar. <i>Additional keys on page 26.</i>
US-47		Guide Shoe Insert , 5-3/4" long, rounded back, for 8 and 16 lb. rails for assembly #960-00034-000
US-47A		Guide Shoe Insert , 5-3/4" long, slot 5/8" x 1-3/4" deep, for Model 8ST for assembly #960-00036-000

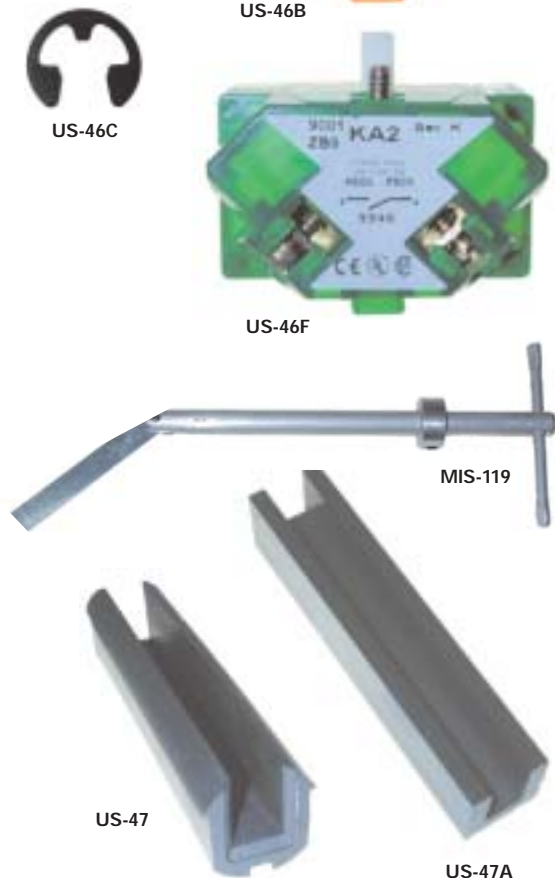

Wheels



USW-1



USW-2



USW-3



USW-4



USW-7

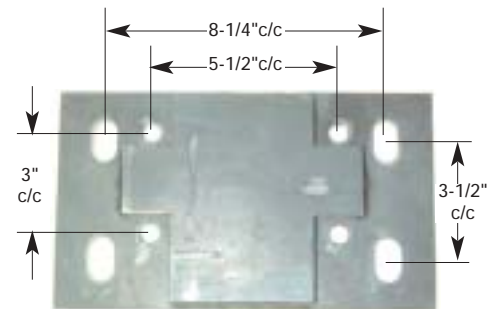

USW-36A



USW-5

USW-4



USW-6

USW-8

S.E.E.S. #	U.S. #	Description
USW-1	100-00080-001	Roller guide wheel 6" dia., polyurethane tire, face 5/8" W
USW-2	100-00054-001	Roller guide assembly , for Car, with 6" dia. wheels USW-1. Mounting holes 5-1/2" c/c
USW-3	100-00075-001	Roller guide assembly , 6" dia. Original mounting holes 8-1/4" c/c. Replacement kit consists of USW-2 roller guide assembly and USW-36A adapter
USW-7	100-00100-001, 100-00100-002	Bolt and Bushing Kit for 3" and 6" roller replacement
USW-36A	100-00004-001	Adapter plate for USW-2 when used to replace old style 6" diameter roller guide assembly. Bolt mounting pattern (shown above)
USW-4	114-00009-007	Roller guide wheel 3-1/4" .625 I.D., tire face 15/16" W
USW-5	100-00057-001	Roller guide assembly for Hydro, with 3-1/4" dia. wheels USW-4
USW-6	114-00054-001	Roller guide assembly for counterweight, with 3-1/4" dia. wheels USW-4
USW-8	960-00011-000	Bearing for governor and roller guide wheels